

INSTALLATION INSTRUCTIONS

READ IMPORTANT SAFETY TIPS BEFORE PROCEEDING WITH INSTALLATION

SAFETY TIPS

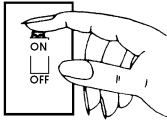

Turn fixture off! (Place wall switch in off position, if fixture has built-in switch or chain pull, switch or pull chain so fixture is off.)



Next - go to the main fuse box. If your fuse box has an ON/OFF switch, simply place main power switch in OFF position.

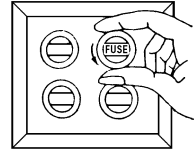

Screw-in type fuses - unscrew the fuse or fuses that control the power to the fixture or room you are working in.

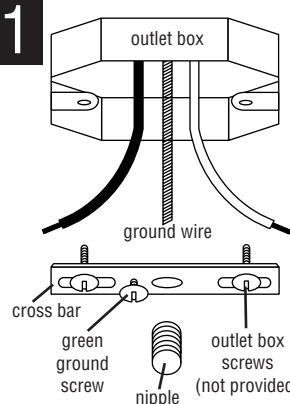

1 ATTACH CROSS BAR to outlet box with outlet box screws (not provided). THREAD NIPPLE into cross bar. Adjust nipple to proper height for mounting fixture.

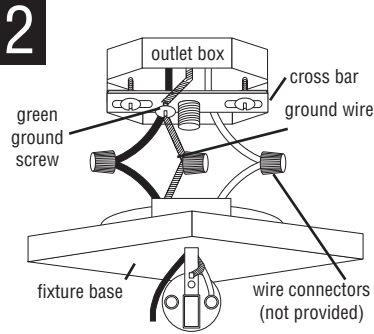

2 **CONNECT THE WIRES.** NOTE: Attach the black fixture wire(s) to black supply wire, and the white fixture wire(s) to white supply wire. Do not mix them up. Use wire connectors (not provided).

GROUNDING INSTRUCTIONS: Wrap the ground wire from the outlet box (bare metal or green insulated wire) around the green ground screw (D) on the mounting bar (A). Leave a free end to extend out from the screw. Connect the ground wire(s) from the fixture to the free end of the outlet box ground with a wire connector. **NEVER CONNECT GROUND WIRE TO BLACK OR WHITE POWER SUPPLY WIRES**

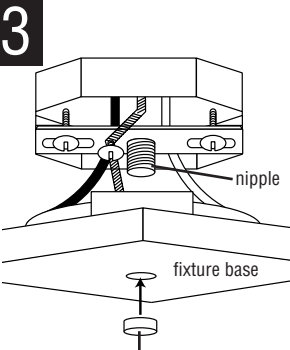

3 POSITION THE FIXTURE BASE over the nipple and secure into place with the fixture mounting knob.

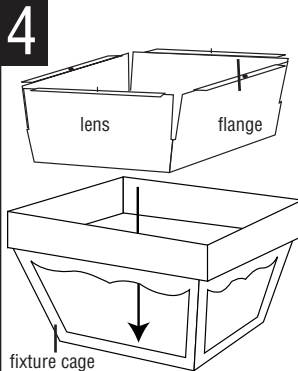

4 INSTALL LENSES into cage. Place flat lens in bottom and insert four side lenses as shown.

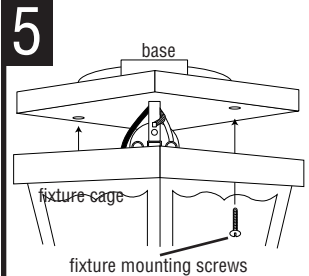

5 SCREW LIGHT BULB(S) INTO SOCKET. Be sure to use bulb with wattage no greater than specified for this fixture. Align holes in cage with holes in base and secure with fixture mounting screws provided.



Clean only with mild soap and water. Avoid spraying with cleaners, insecticides, and pesticides that are petroleum based hydrocarbon products. These will degrade luminaire.