

INSTALLATION INSTRUCTIONS

READ IMPORTANT SAFETY TIPS BEFORE PROCEEDING WITH INSTALLATION

SAFETY TIPS

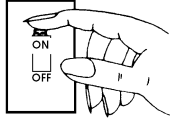

Turn fixture off! (Place wall switch in off position, if fixture has built-in switch or chain pull, switch or pull chain so fixture is off.)



Next - go to the main fuse box. If your fuse box has an ON/OFF switch, simply place main power switch in OFF position.

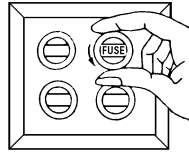

Screw-in type fuses - unscrew the fuse or fuses that control the power to the fixture or room you are working in.

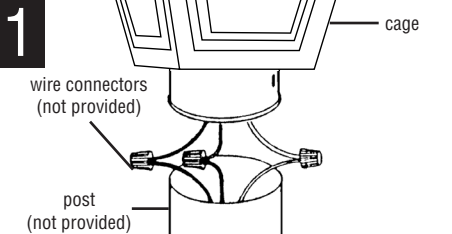

1 CONNECT THE WIRES. NOTE: Attach the black fixture wire to the black supply wire, the white fixture wire to the white supply wire. Do not mix them up. Use approved wire connectors (not provided).

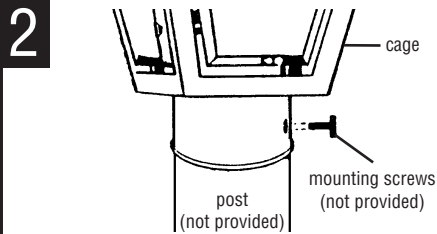

2 POSITION THE FIXTURE over the post as shown. For permanent mounting, fasten with set screw at hole in post collar by drilling hole at same location through post and securing with screw.

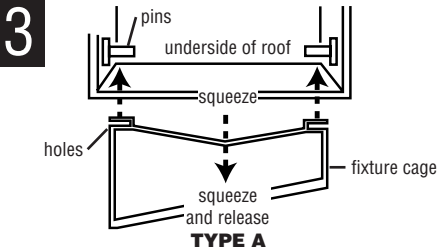

3 ATTACH THE FIXTURE ROOF TO FIXTURE CAGE. Squeeze cage as shown. Position holes on side of cage over corresponding pins on underside of roof. Release cage - pins will snap into position.

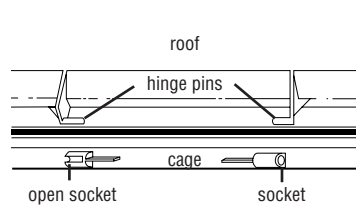

3 ATTACH THE FIXTURE ROOF TO FIXTURE CAGE. Slip one hinge pin on roof into hole in socket on cage and snap other hinge pin into open socket.

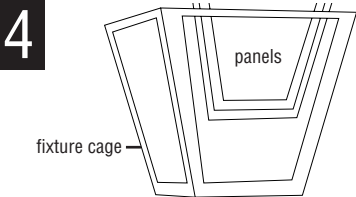

4 BEFORE SNAPPING HOUSING SHUT, install plastic panels, textured or beveled side out, by sliding panels down cage in slots on inside of cage. Make sure panels are all the way down into seats in cage. Some panels may fit tighter than others and a moderate amount of force may be required to install.

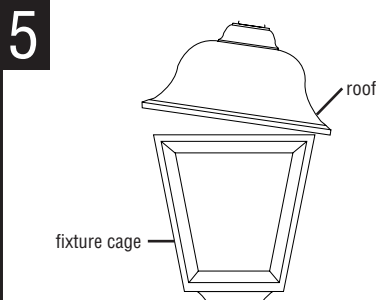

5 Lower roof and snap into place.

INSTALLATION INSTRUCTIONS

READ IMPORTANT SAFETY TIPS BEFORE PROCEEDING WITH INSTALLATION

SAFETY TIPS

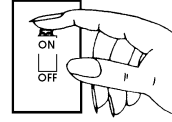

Turn fixture off! (Place wall switch in off position, if fixture has built-in switch or chain pull, switch or pull chain so fixture is off.)



Next - go to the main fuse box. If your fuse box has an ON/OFF switch, simply place main power switch in OFF position.

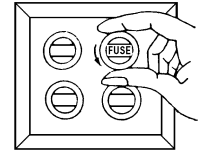

Screw-in type fuses - unscrew the fuse or fuses that control the power to the fixture or room you are working in.

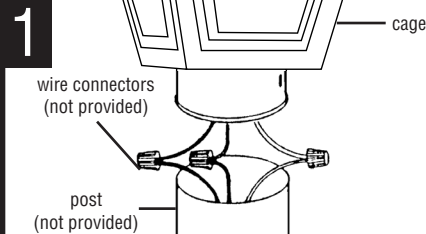

1 CONNECT THE WIRES. NOTE: Attach the black fixture wire to the black supply wire, the white fixture wire to the white supply wire. Do not mix them up. Use approved wire connectors (not provided).

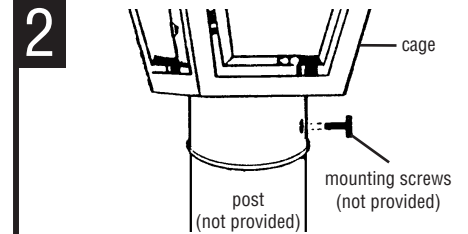

2 POSITION THE FIXTURE over the post as shown. For permanent mounting, fasten with set screw at hole in post collar by drilling hole at same location through post and securing with screw.

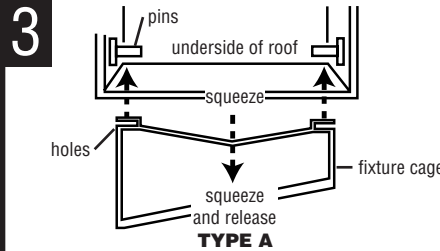

3 ATTACH THE FIXTURE ROOF TO FIXTURE CAGE. Squeeze cage as shown. Position holes on side of cage over corresponding pins on underside of roof. Release cage - pins will snap into position.

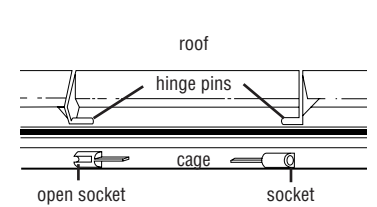

3 ATTACH THE FIXTURE ROOF TO FIXTURE CAGE. Slip one hinge pin on roof into hole in socket on cage and snap other hinge pin into open socket.

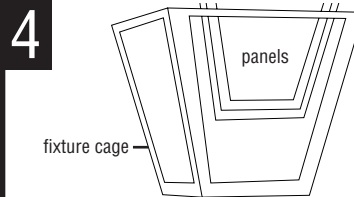

4 BEFORE SNAPPING HOUSING SHUT, install plastic panels, textured or beveled side out, by sliding panels down cage in slots on inside of cage. Make sure panels are all the way down into seats in cage. Some panels may fit tighter than others and a moderate amount of force may be required to install.

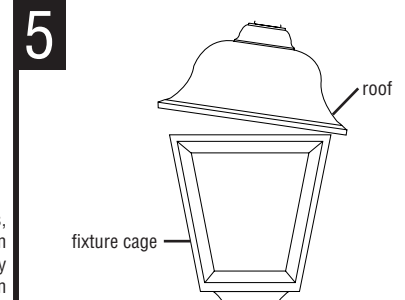

5 Lower roof and snap into place.



Clean only with mild soap and water. Avoid spraying with Cleansers, Insecticides, and Pesticides that a petroleum based hydrocarbon products. These will degrade Luminaire.

CAUTION: Do not turn on without diffuser installed. Do not touch LEDs or circuit board. LED optics could be damaged. No lamp replacement required! Integral LED light engine supplied. Do not remove protective cover from LED light engine.



Clean only with mild soap and water. Avoid spraying with Cleansers, Insecticides, and Pesticides that a petroleum based hydrocarbon products. These will degrade Luminaire.

CAUTION: Do not turn on without diffuser installed. Do not touch LEDs or circuit board. LED optics could be damaged. No lamp replacement required! Integral LED light engine supplied. Do not remove protective cover from LED light engine.
