

INSTALLATION INSTRUCTIONS

READ IMPORTANT SAFETY TIPS BEFORE PROCEEDING WITH INSTALLATION

SAFETY TIPS

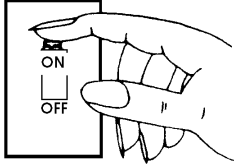

Turn fixture off! (Place wall switch in off position, if fixture has built-in switch or chain pull, switch or pull chain so fixture is off.)

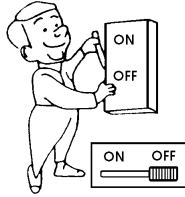

Next - go to the main fuse box. If your fuse box has an ON/OFF switch, simply place main power switch in OFF position

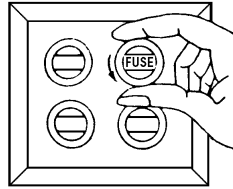

Screw-in type fuses - unscrew the fuse or fuses that control the power to the fixture or room you are working in.

INSTALLATION INSTRUCTIONS

READ IMPORTANT SAFETY TIPS BEFORE PROCEEDING WITH INSTALLATION

SAFETY TIPS

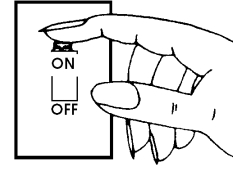

Turn fixture off! (Place wall switch in off position, if fixture has built-in switch or chain pull, switch or pull chain so fixture is off.)

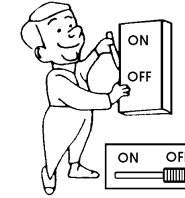

Next - go to the main fuse box. If your fuse box has an ON/OFF switch, simply place main power switch in OFF position

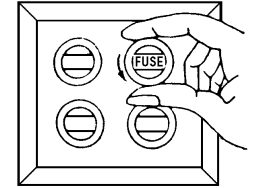

Screw-in type fuses - unscrew the fuse or fuses that control the power to the fixture or room you are working in.

1

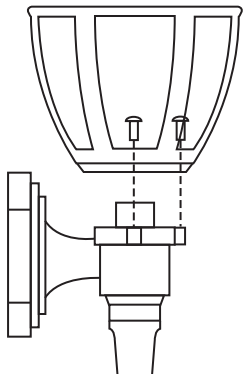

FASTEN THE CAGE to the fixture base with the three screws provided.

2

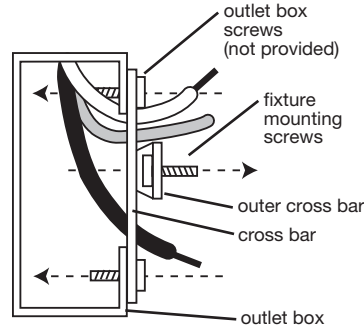

THREAD fixture mounting screws (provided) into outer cross bar.
ATTACH cross bar to outlet box with outlet box screws (not provided).

3

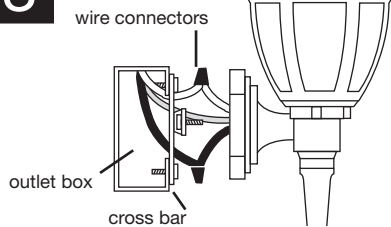

CONNECT THE WIRES. NOTE: Attach black fixture wire to black supply wire, white fixture wire to white supply wire. Do not mix them up. Use approved electrical tape or wire connectors (not provided). Connect bare fixture ground wire to ground wire from outlet box. NEVER CONNECT GROUND WIRE TO BLACK OR WHITE POWER SUPPLY WIRES!

4

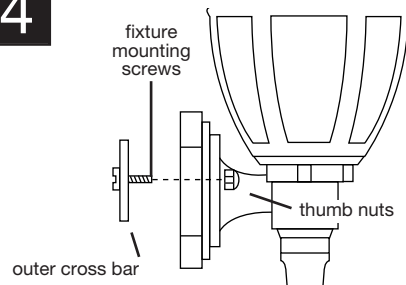

POSITION THE FIXTURE HOUSING over the fixture mounting screws and secure in place with the thumb nuts provided.

(INSTRUCTIONS CONTINUE ON BACK SIDE)

IS005PC-08

1

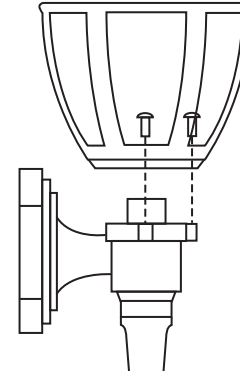

FASTEN THE CAGE to the fixture base with the three screws provided.

2

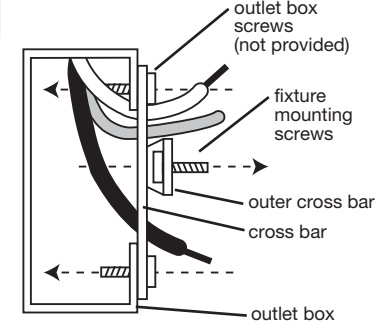

THREAD fixture mounting screws (provided) into outer cross bar.
ATTACH cross bar to outlet box with outlet box screws (not provided).

3

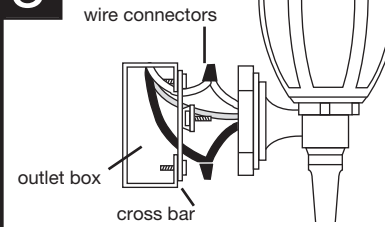

CONNECT THE WIRES. NOTE: Attach black fixture wire to black supply wire, white fixture wire to white supply wire. Do not mix them up. Use approved electrical tape or wire connectors (not provided). Connect bare fixture ground wire to ground wire from outlet box. NEVER CONNECT GROUND WIRE TO BLACK OR WHITE POWER SUPPLY WIRES!

4

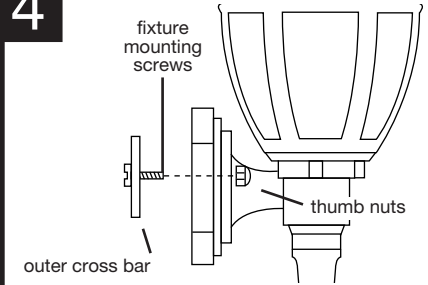

POSITION THE FIXTURE HOUSING over the fixture mounting screws and secure in place with the thumb nuts provided.

(INSTRUCTIONS CONTINUE ON BACK SIDE)

IS005PC-08

INSTALLATION INSTRUCTIONS

(CONTINUED FROM OTHER SIDE)

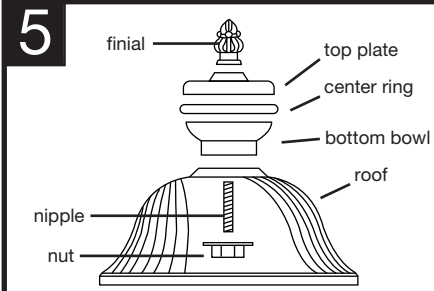

5 FASTEN DECORATIVE TOP to roof as shown in illustration below. (Where Applicable)

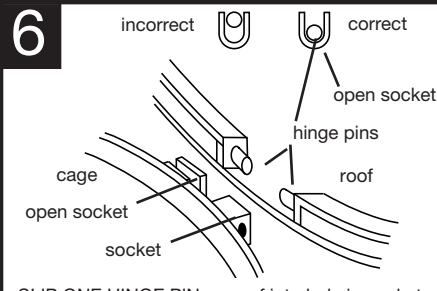

6 SLIP ONE HINGE PIN on roof into hole in socket on cage and snap other hinge pin into open socket. Be sure hinge pin is completely seated in open socket.

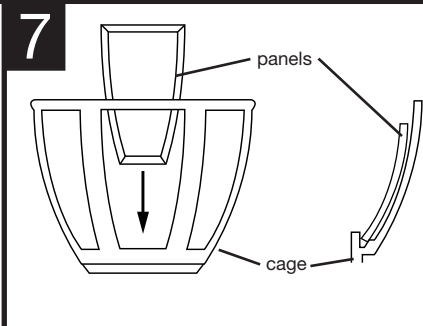

7 INSTALL PLASTIC PANELS, beveled side out, by sliding panels down cage in slots on inside of cage. Make sure panels are all the way down into seats in cage.

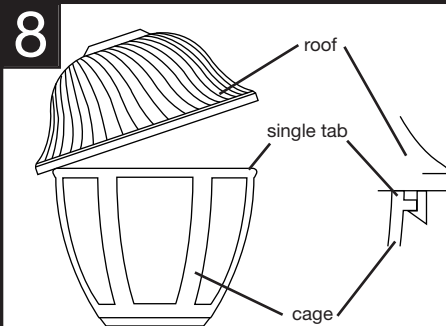

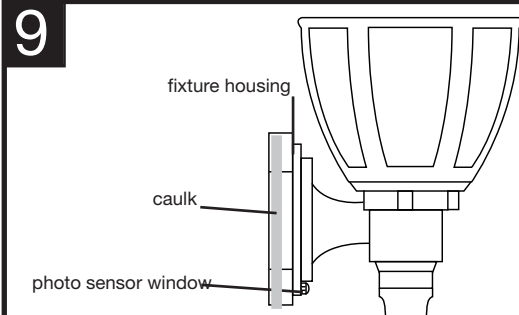

8 SCREW LIGHT BULB INTO SOCKET. Be sure to use bulb with wattage no greater than specified for this fixture. Lower roof and snap into place. See assembly illustration.

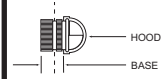

9 NOTE: Fixture MUST be caulked with an acrylic caulk where fixture housing meets mounting surface. This provides a water tight seal when fixture is installed.

THIS FIXTURE MAY HAVE AN INTEGRAL PHOTO SENSOR THAT TURNS THE FIXTURE OFF DURING THE DAY AND ON AT NIGHT. THE PHOTO SENSOR IS NOT ADJUSTABLE. THE FIXTURE COULD POSSIBLY CYCLE ON AND OFF DUE TO LIGHT REFLECTED FROM NEAR BY SURFACES INTO THE PHOTO SENSOR. IF CYCLING OCCURS, REMOVE THE PHOTO SENSOR NUT AND INSTALL THE SWIVEL HOOD AND BASE.
 THE HOOD AND BASE IS ADJUSTABLE. HOOD CAN BE ROTATED AND BASE CAN BE CUT ALONG DOTTED LINE TO REDUCE OVERALL LENGTH. CHECK OPERATION BEFORE CUTTING THE BASE.



 CLEAN ONLY WITH MILD SOAP AND WATER. AVOID SPRAYING WITH CLEANSERS, INSECTICIDES, AND PESTICIDES THAT ARE PETROLEUM BASED HYDROCARBON PRODUCTS. THESE WILL DEGRADE LUMINAIRE.

INSTALLATION INSTRUCTIONS

(CONTINUED FROM OTHER SIDE)

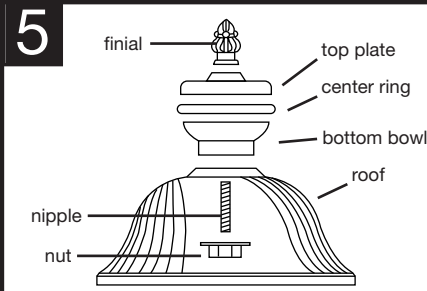

5 FASTEN DECORATIVE TOP to roof as shown in illustration below. (Where Applicable)

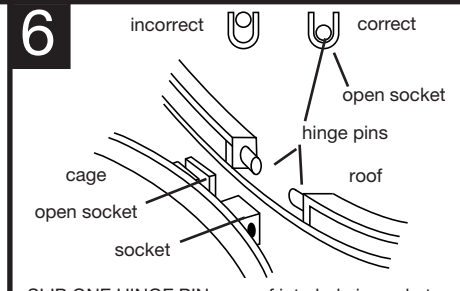

6 SLIP ONE HINGE PIN on roof into hole in socket on cage and snap other hinge pin into open socket. Be sure hinge pin is completely seated in open socket.

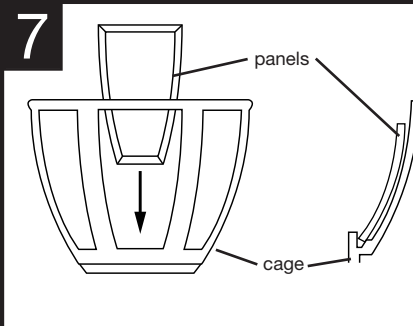

7 INSTALL PLASTIC PANELS, beveled side out, by sliding panels down cage in slots on inside of cage. Make sure panels are all the way down into seats in cage.

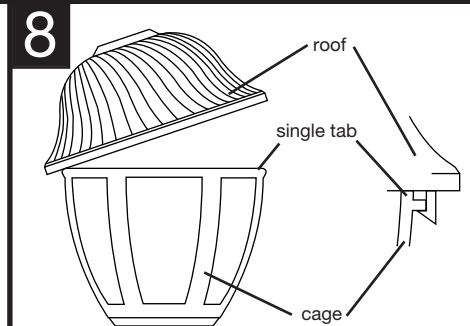

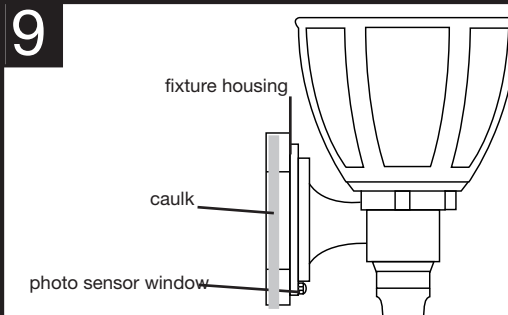

8 SCREW LIGHT BULB INTO SOCKET. Be sure to use bulb with wattage no greater than specified for this fixture. Lower roof and snap into place. See assembly illustration.

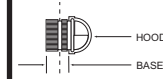

9 NOTE: Fixture MUST be caulked with an acrylic caulk where fixture housing meets mounting surface. This provides a water tight seal when fixture is installed.

THIS FIXTURE MAY HAVE AN INTEGRAL PHOTO SENSOR THAT TURNS THE FIXTURE OFF DURING THE DAY AND ON AT NIGHT. THE PHOTO SENSOR IS NOT ADJUSTABLE. THE FIXTURE COULD POSSIBLY CYCLE ON AND OFF DUE TO LIGHT REFLECTED FROM NEAR BY SURFACES INTO THE PHOTO SENSOR. IF CYCLING OCCURS, REMOVE THE PHOTO SENSOR NUT AND INSTALL THE SWIVEL HOOD AND BASE.
 THE HOOD AND BASE IS ADJUSTABLE. HOOD CAN BE ROTATED AND BASE CAN BE CUT ALONG DOTTED LINE TO REDUCE OVERALL LENGTH. CHECK OPERATION BEFORE CUTTING THE BASE.



 CLEAN ONLY WITH MILD SOAP AND WATER. AVOID SPRAYING WITH CLEANSERS, INSECTICIDES, AND PESTICIDES THAT ARE PETROLEUM BASED HYDROCARBON PRODUCTS. THESE WILL DEGRADE LUMINAIRE.