

STONE SERIES INSTALLATION GUIDE

MODELS: S32WC, S32WL, S32WC-13M, S32WL-13M, S32WC-18E, S32WL-18E, S32WC-G13, S32WL-G13, S32WC-G18, S32WL-G18, S32WC-2G13 & S32WL-2G13



If for some reason you are missing parts or have a problem with your fixture
DO NOT CALL OR RETURN TO THE RETAILER. Call for direct assistance at 1-800-321-2132.

PLEASE READ ALL INSTRUCTIONS CAREFULLY BEFORE INSTALLING FIXTURES.

BEFORE INSTALLATION

1. Please check to see that your fixture was not damaged during shipment, and that you received all the hardware needed for installation. While we strive for perfection, accidents do happen. If you have a problem or are missing any parts, please call us at 1-800-321-2132 immediately.
2. **CAUTION: Disconnect main power at the breaker box before beginning installation. Do not turn power off at the wall switch only. Failure to properly disconnect the main power supply may result in serious injury.**
3. **CAUTION: Install the appropriate size lamp in your Stone fixture. Do not exceed the manufacturer's maximum wattage restrictions.**
4. **SPECIAL NOTE: For easier installation, it is recommended that two (2) people be used when making the electrical connections and mounting the fixture.**

HARDWARE

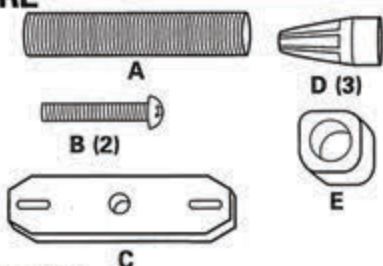

INSTALLATION TOOLS REQUIRED

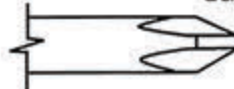
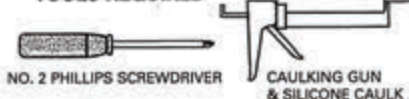

TIP SHOWN ACTUAL SIZE

INSTALLATION

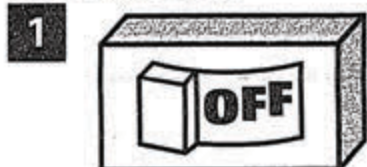

Disconnect main power supply at the breaker box. DO NOT turn power off at the wall switch only.

CAUTION: FAILURE TO DISCONNECT MAIN ELECTRICAL POWER MAY RESULT IN SERIOUS INJURY.

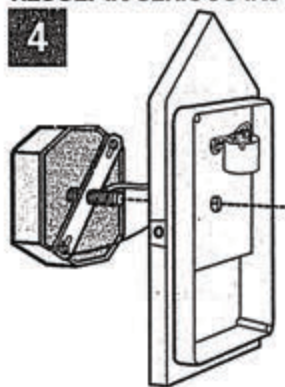
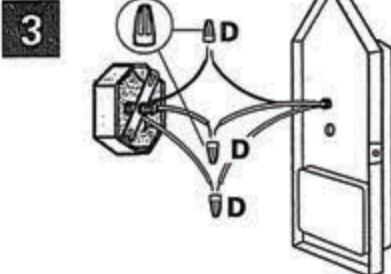
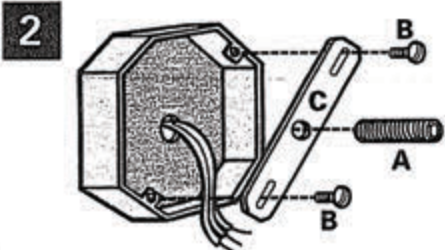

6
MODELS S32WC, S32WL
Place incandescent light bulb in socket. Be sure not to exceed maximum wattage of 60 watts.
MODELS S32WC-13M, S32WL-13M
Snap in twin tube, 2 PIN PL-S 13 watt fluorescent lamp, (NEMA DESIGNATION CFT13W/GX23).

PLEASE NOTE
Failure to change your 13 watt lamp on a timely basis could damage your ballast and void the warranty. Do not wait for the lamp to completely burn out. When it begins to flicker, replace the lamp immediately.

MODELS S32WC-18E, S32WL-18E
Snap in quad tube, 4 PIN PL-C 18 watt fluorescent lamp, (NEMA DESIGNATION CFQ18W/G24q).

MODELS S32WC-G13, S32WL-G13, S32WC-G18, S32WL-G18, S32WC-2G13, S32WL-2G13
Install integrated lamp/ballast (SBCFL). Use SBCFL specified on fixture. Grasp the plastic base, insert pins into socket and rotate clockwise until secure.

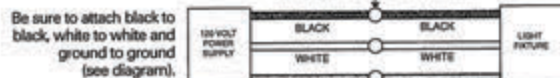

BULB INSTALLATION

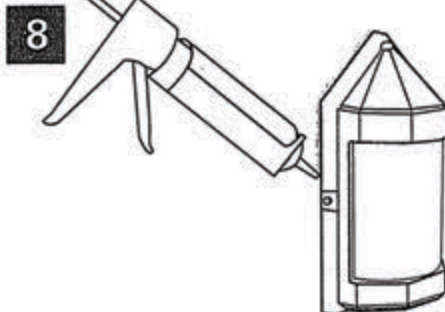
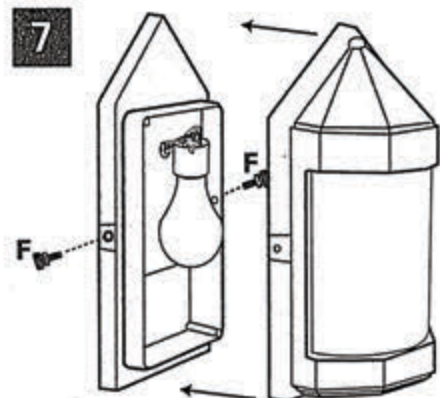
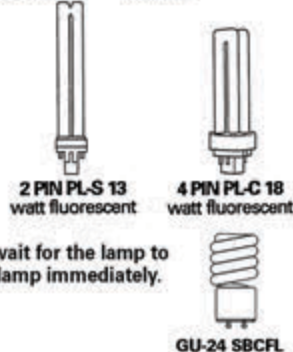

Apply silicone caulk completely around the fixture backplate for a watertight seal.

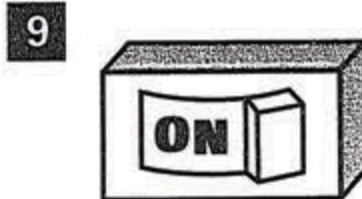

TURN ON MAIN POWER

This fixture may have an integral photo sensor that turns the fixture off during the day and on at night. The photo sensor is not adjustable. The fixture could possibly cycle on and off due to light reflected from near by surfaces into the photo sensor. If cycling occurs, remove the photo sensor nut and install the swivel hood and base.

The hood and base is adjustable. Hood can be rotated and base can be cut along dotted line to reduce overall length. Check operation before cutting the base.

Customer Service 1-877-870-9283

1102457 Rev B

www.wavelighting.com

